



# Mobility RAN P&I Hardware Standards: **Confidential**

AT&T Proprietary (Internal Use Only)

Not for use or disclosure outside the AT&T companies, except under written agreement.

©2018 AT&T Intellectual Property. All rights reserved.

## **INTRODUCTION**

### **Reason For Current Issue**

#### **Overview**

#### **About This Document**

##### **Audience**

##### **Related Documentation**

##### **Contacts**

### **Connector Weatherproofing Specifications and Practices**

#### **Connector Weatherproofing Approved Products/Methods**

#### **Weatherproofing Product Application Table**

### **Connector Guidelines**

### **Weatherproofing Approved Products**

#### **Tape & Butyl**

#### **Cold Shrink**

#### **Enclosures (Clamshells)**

#### **Self-Amalgamating Tape**

#### **Jumper Boots**

#### **Heat Shrink**

### **Shelter, Equipment Room and Conduit Sealing**

#### **Hatchplates**

#### **Shelter Penetrations**

#### **Shelter, Equipment Room and Cabinet Doors**

#### **Conduits**

##### **Vertical Ground Conduits**

##### **Horizontal Above Ground Conduits**

##### **Tower Conduits**

##### **Inter-Cabinet Conduits**

### **Revision Log**

---

AT&T Proprietary (Internal Use Only)

Not for use or disclosure outside the AT&T companies, except under written agreement.

©2018 AT&T Intellectual Property. All rights reserved.

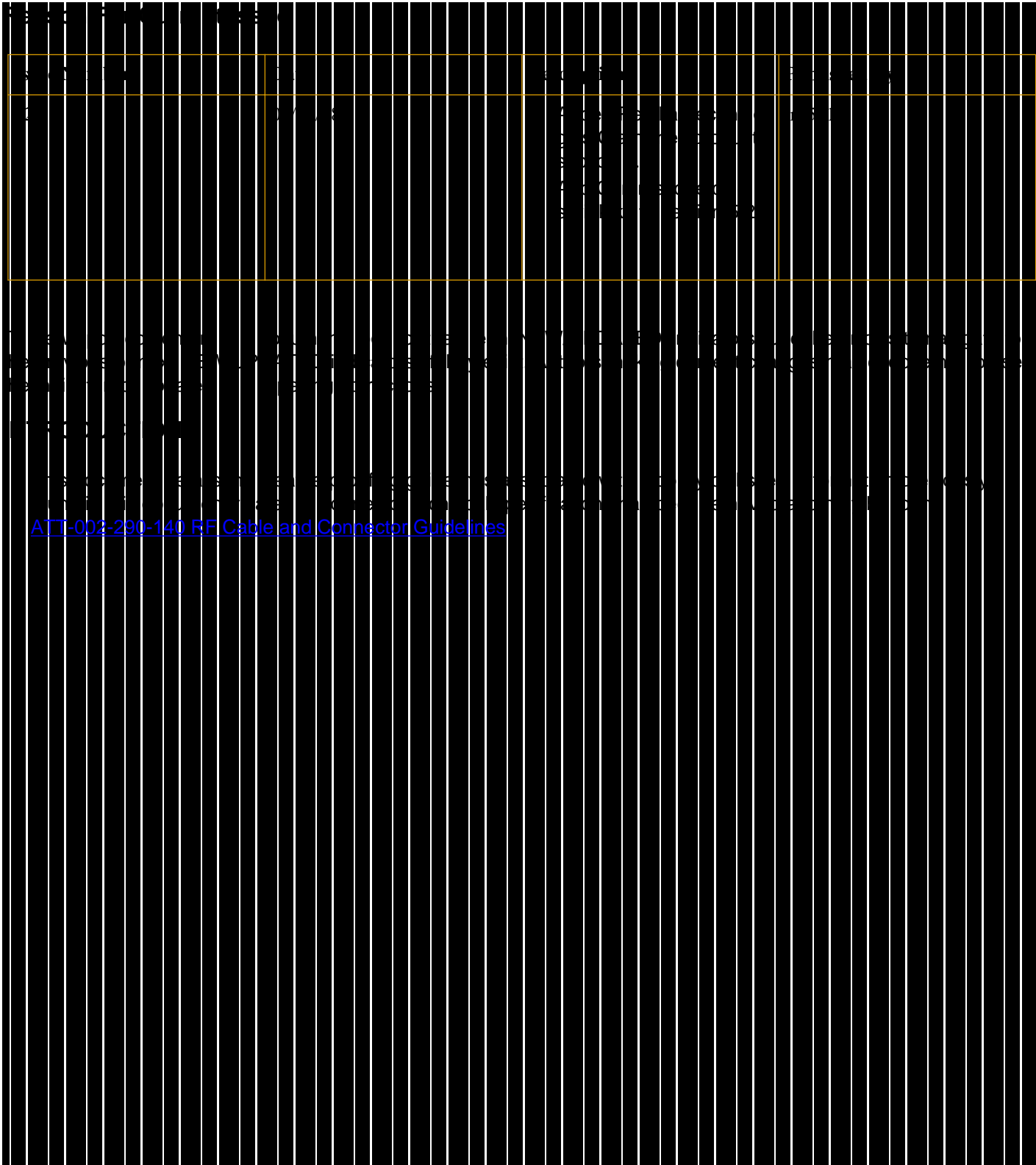

[ATT-002-290-140 RF Cable and Connector Guidelines](#)

---

AT&T Proprietary (Internal Use Only)

Not for use or disclosure outside the AT&T companies, except under written agreement.

©2018 AT&T Intellectual Property. All rights reserved.

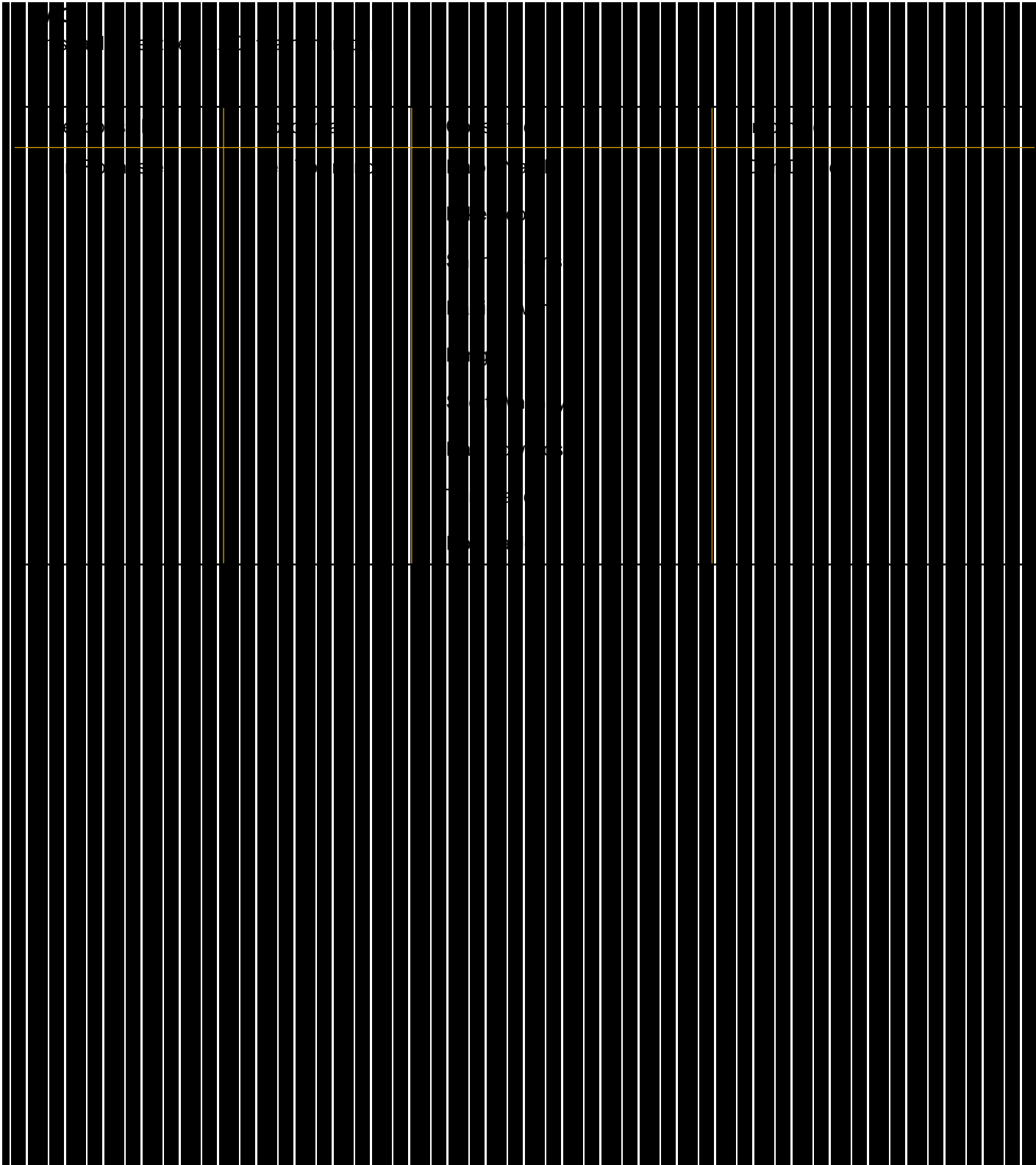

---

AT&T Proprietary (Internal Use Only)

Not for use or disclosure outside the AT&T companies, except under written agreement.

©2018 AT&T Intellectual Property. All rights reserved.

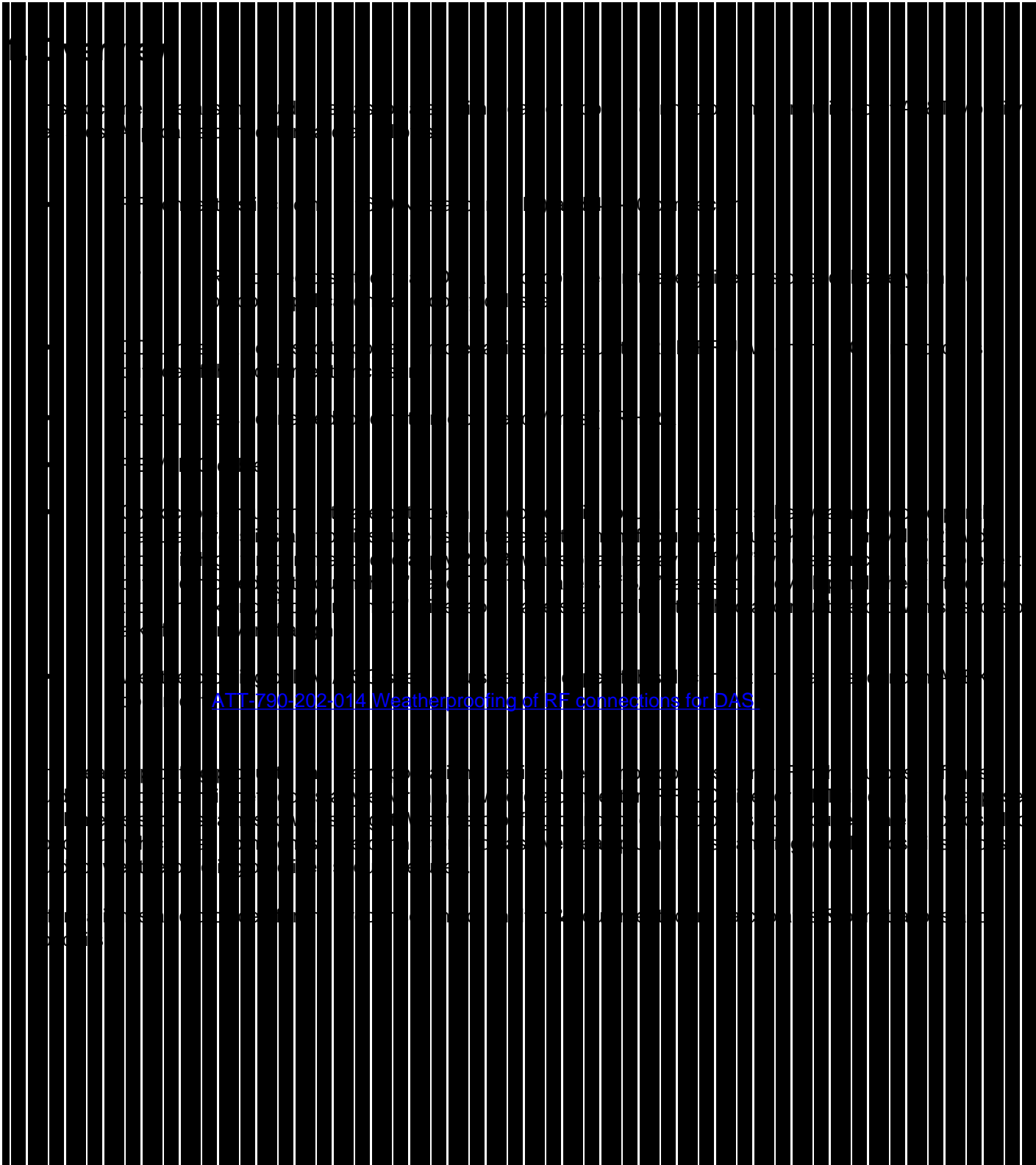

[ATT-790-202-014 Weatherproofing of RF connections for DAS](#)

---

AT&T Proprietary (Internal Use Only)

Not for use or disclosure outside the AT&T companies, except under written agreement.

©2018 AT&T Intellectual Property. All rights reserved.

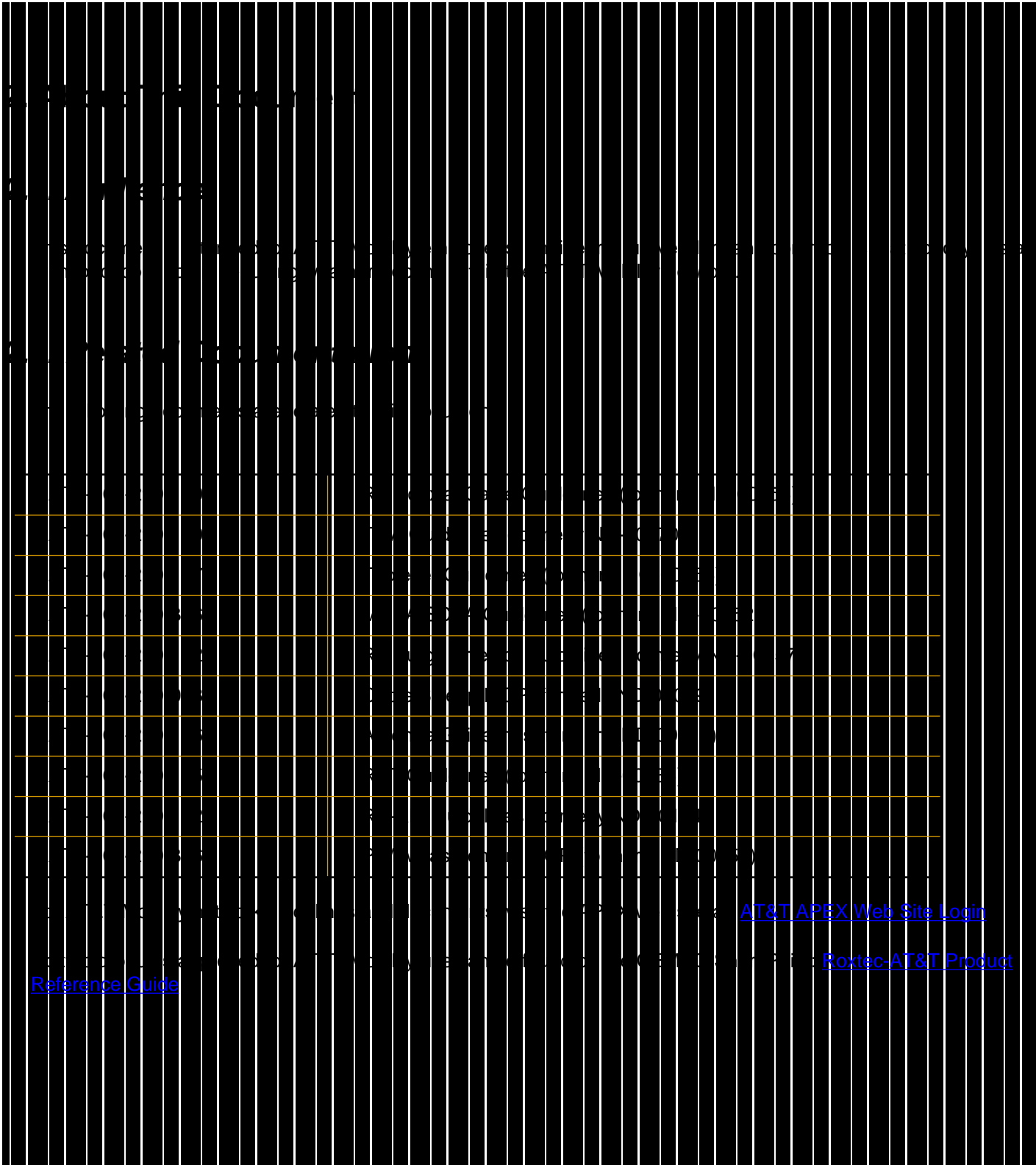

[Reference Guide](#)

[AT&T APEX Web Site Login](#)

[Roxtec-AT&T Product](#)

---

AT&T Proprietary (Internal Use Only)

Not for use or disclosure outside the AT&T companies, except under written agreement.

©2018 AT&T Intellectual Property. All rights reserved.

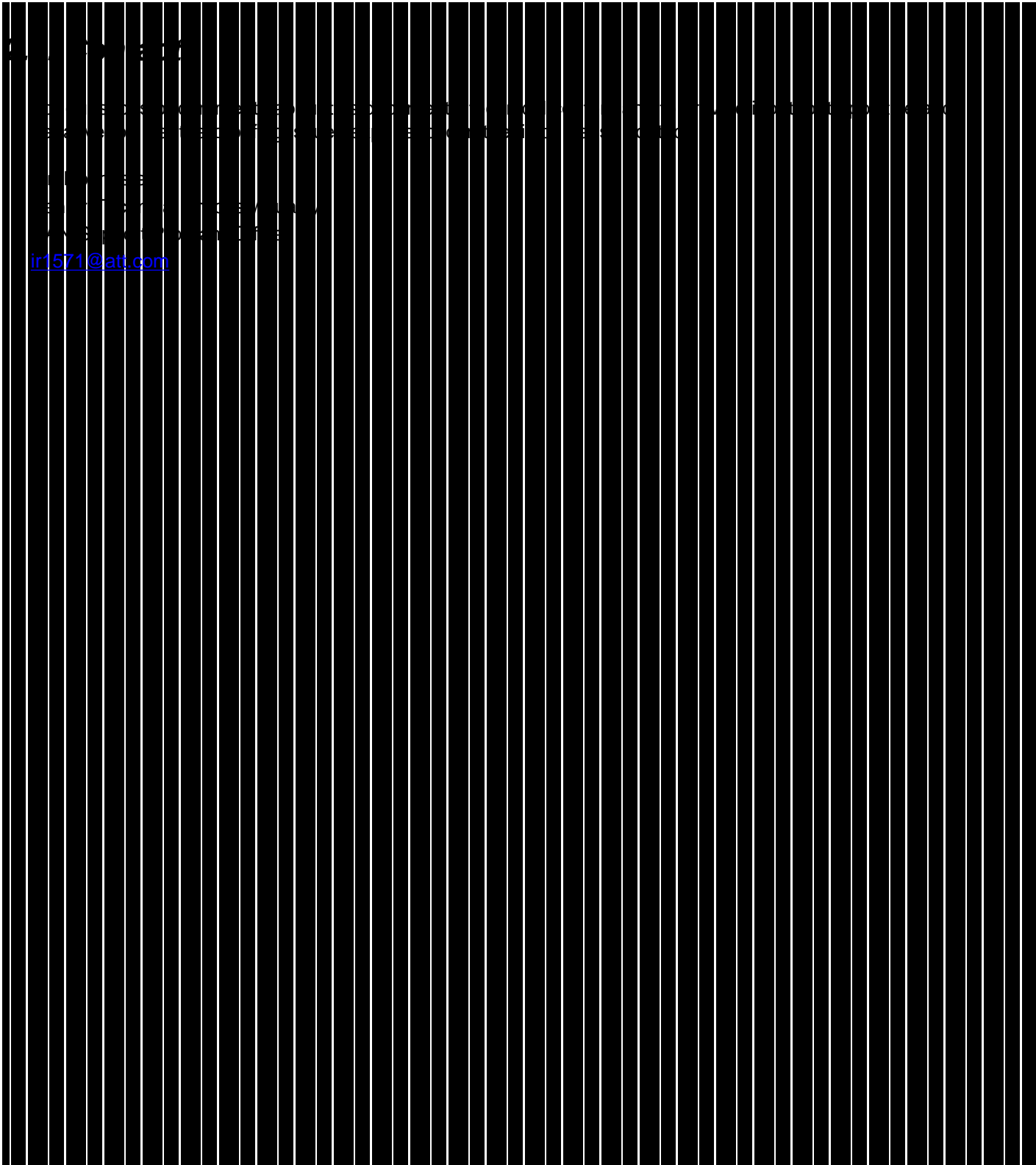

[ir1571@att.com](mailto:ir1571@att.com)

---

AT&T Proprietary (Internal Use Only)

Not for use or disclosure outside the AT&T companies, except under written agreement.

©2018 AT&T Intellectual Property. All rights reserved.

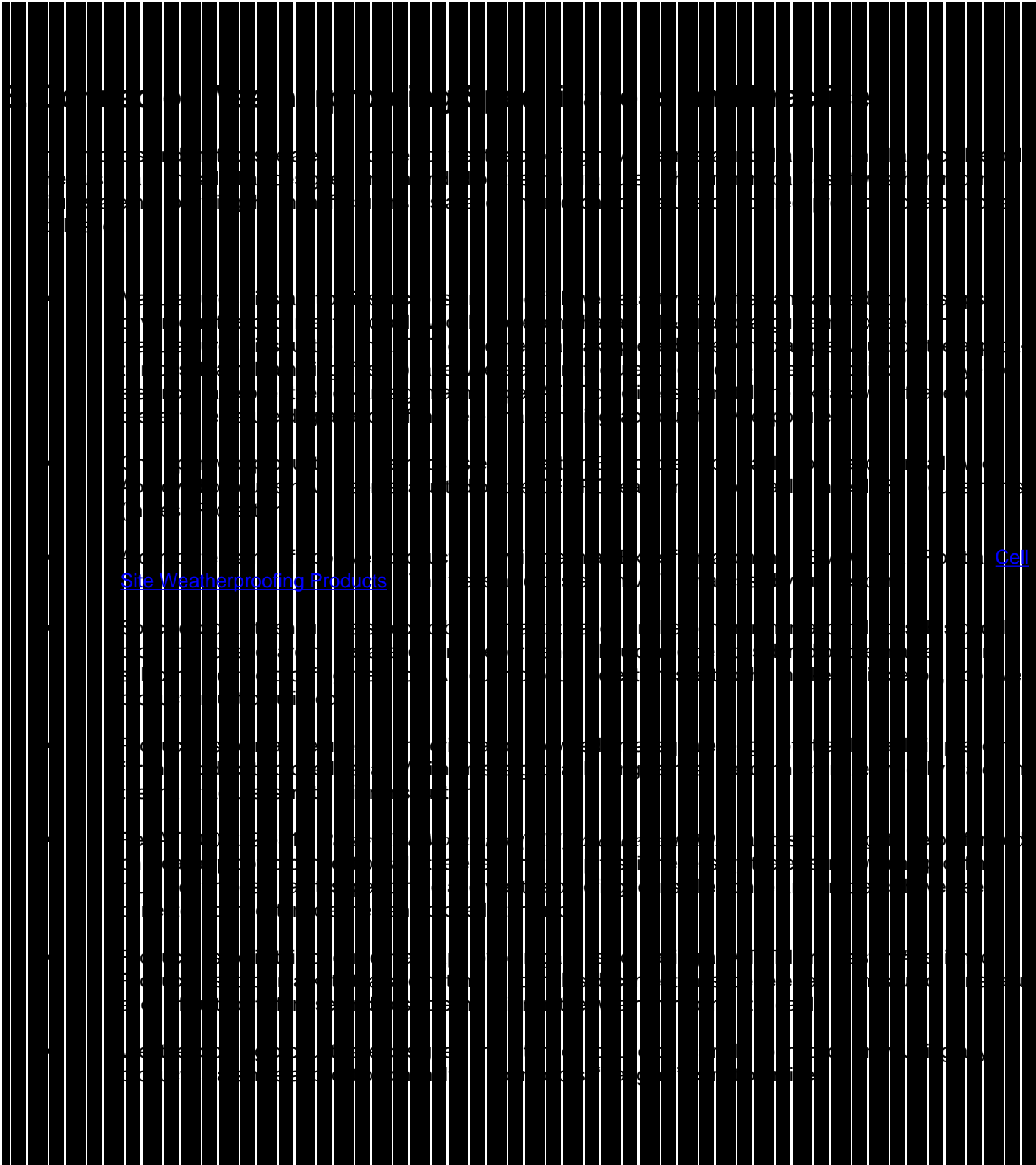

[Site Weatherproofing Products](#)

[Cell](#)

---

AT&T Proprietary (Internal Use Only)

Not for use or disclosure outside the AT&T companies, except under written agreement.

©2018 AT&T Intellectual Property. All rights reserved.



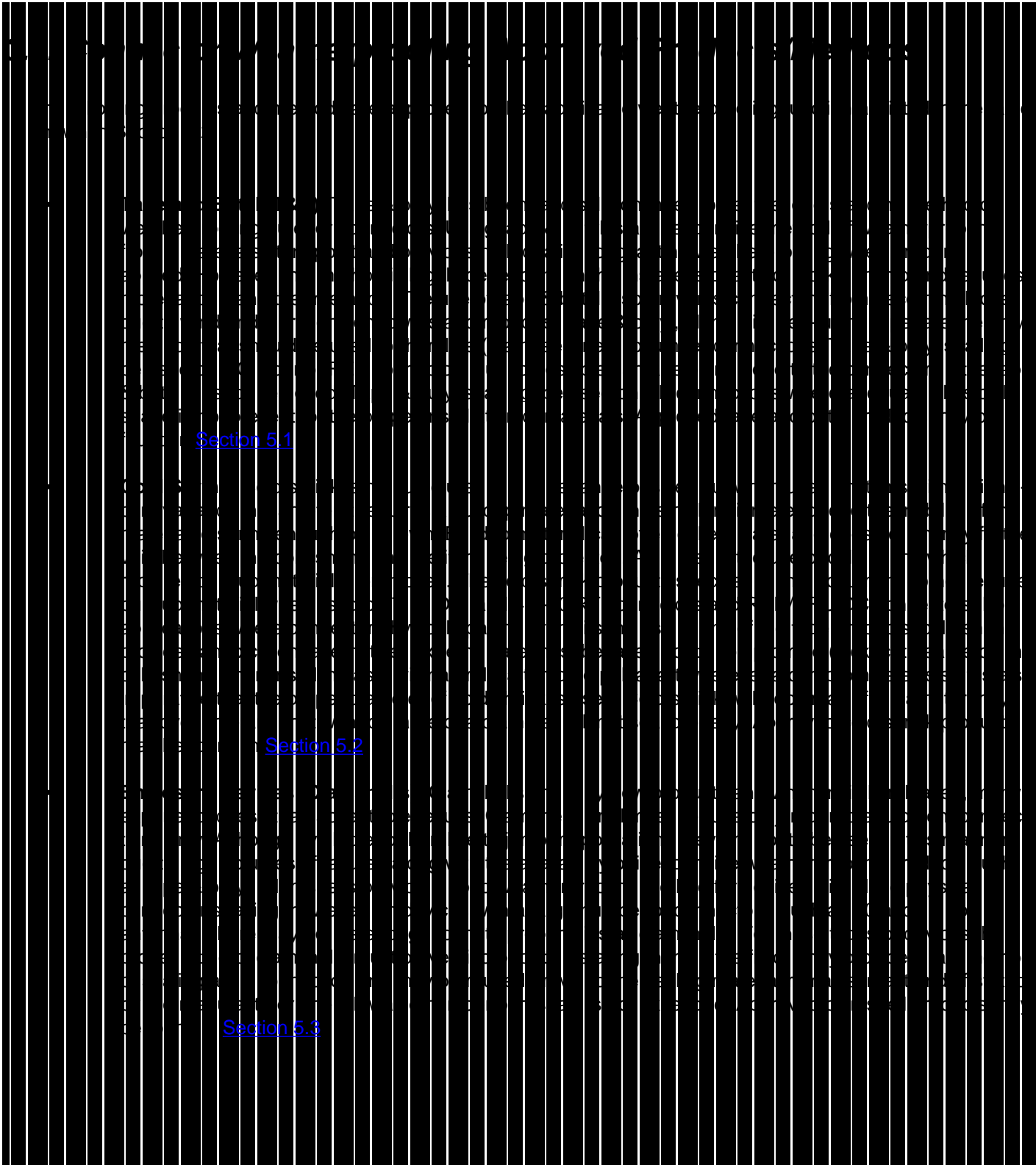

[Section 5.1](#)

[Section 5.2](#)

[Section 5.3](#)

---

AT&T Proprietary (Internal Use Only)

Not for use or disclosure outside the AT&T companies, except under written agreement.

©2018 AT&T Intellectual Property. All rights reserved.

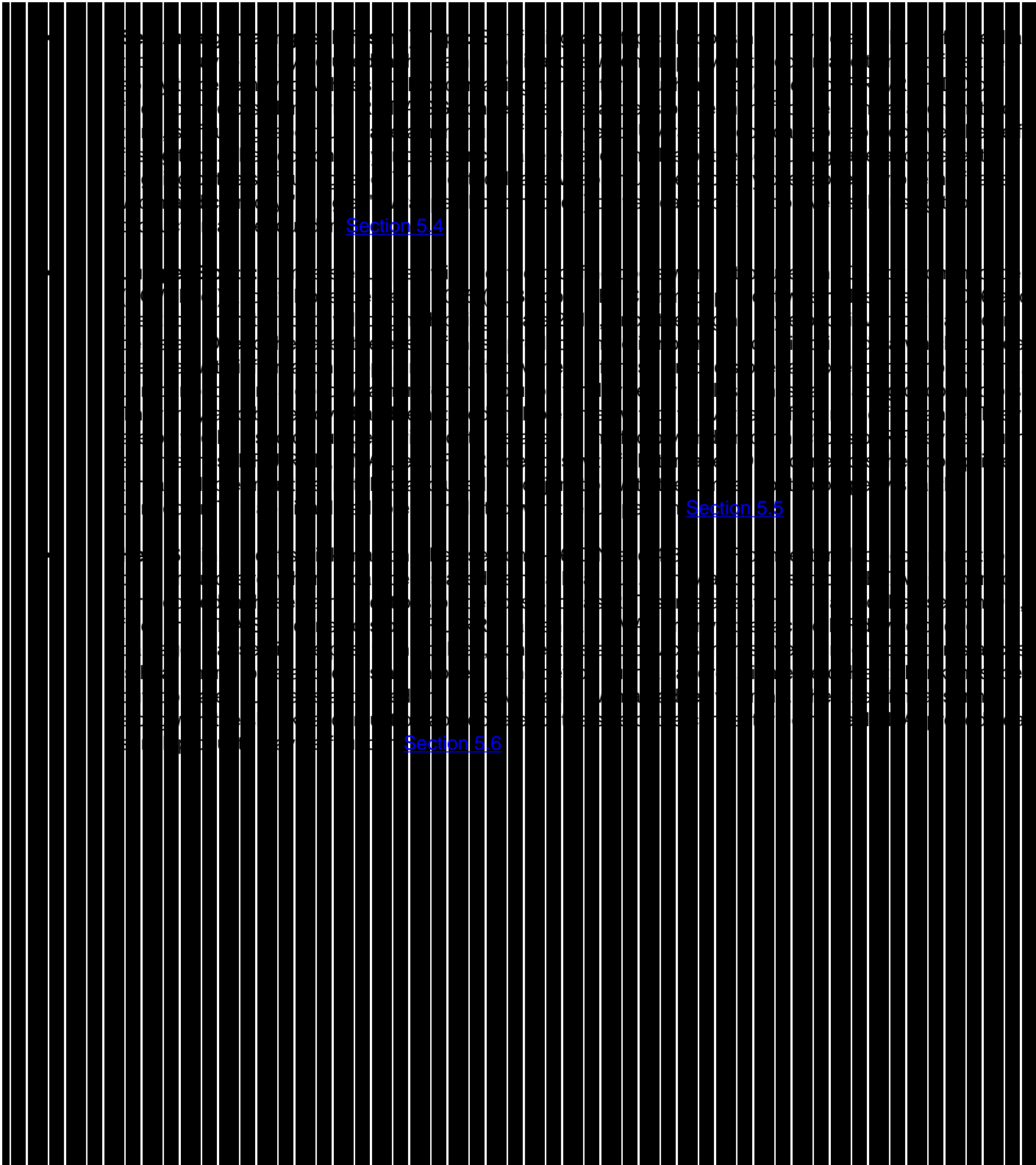

[Section 5.4](#)

[Section 5.5](#)

[Section 5.6](#)

---

AT&T Proprietary (Internal Use Only)

Not for use or disclosure outside the AT&T companies, except under written agreement.

©2018 AT&T Intellectual Property. All rights reserved.

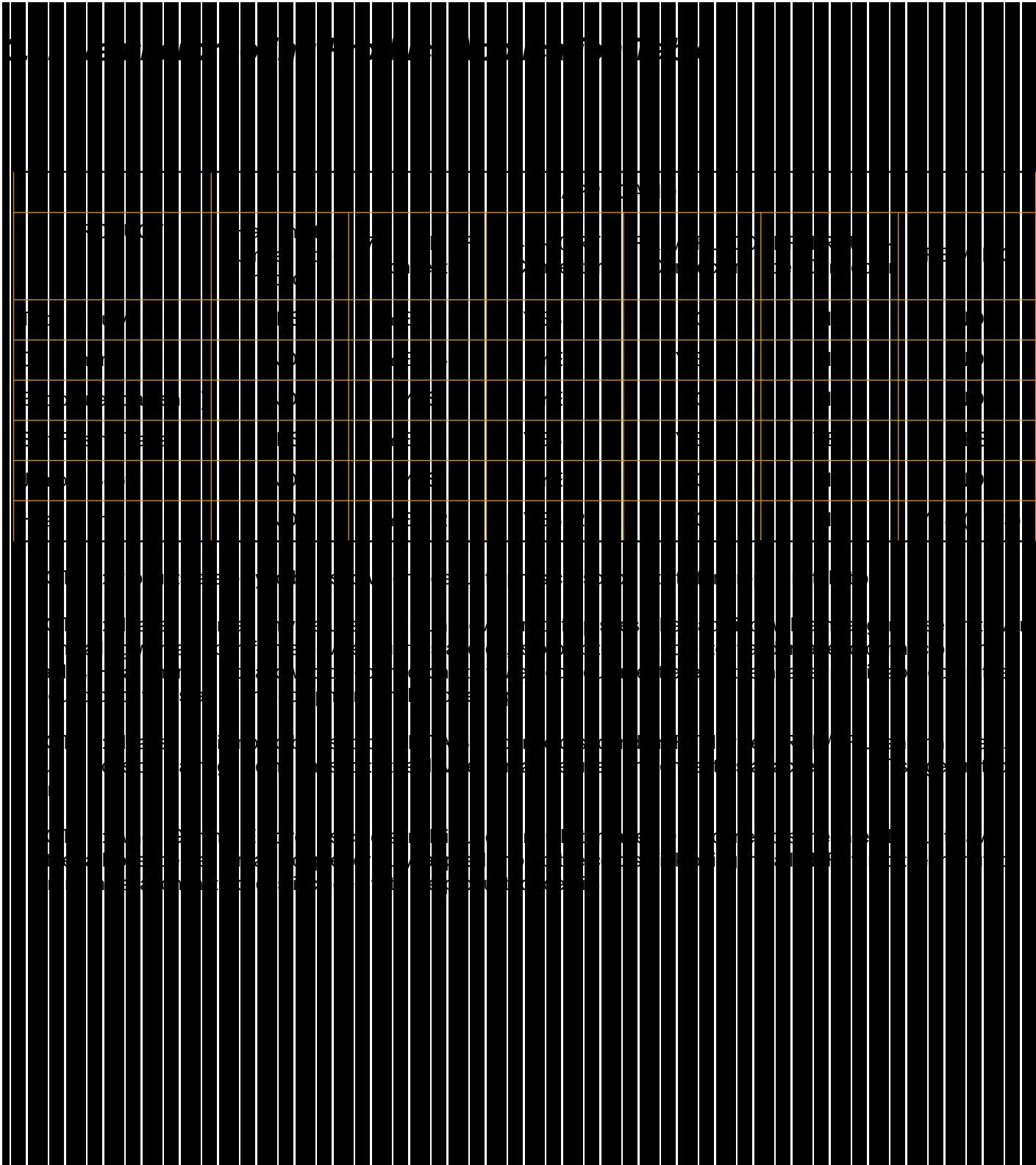

---

AT&T Proprietary (Internal Use Only)

Not for use or disclosure outside the AT&T companies, except under written agreement.

©2018 AT&T Intellectual Property. All rights reserved.

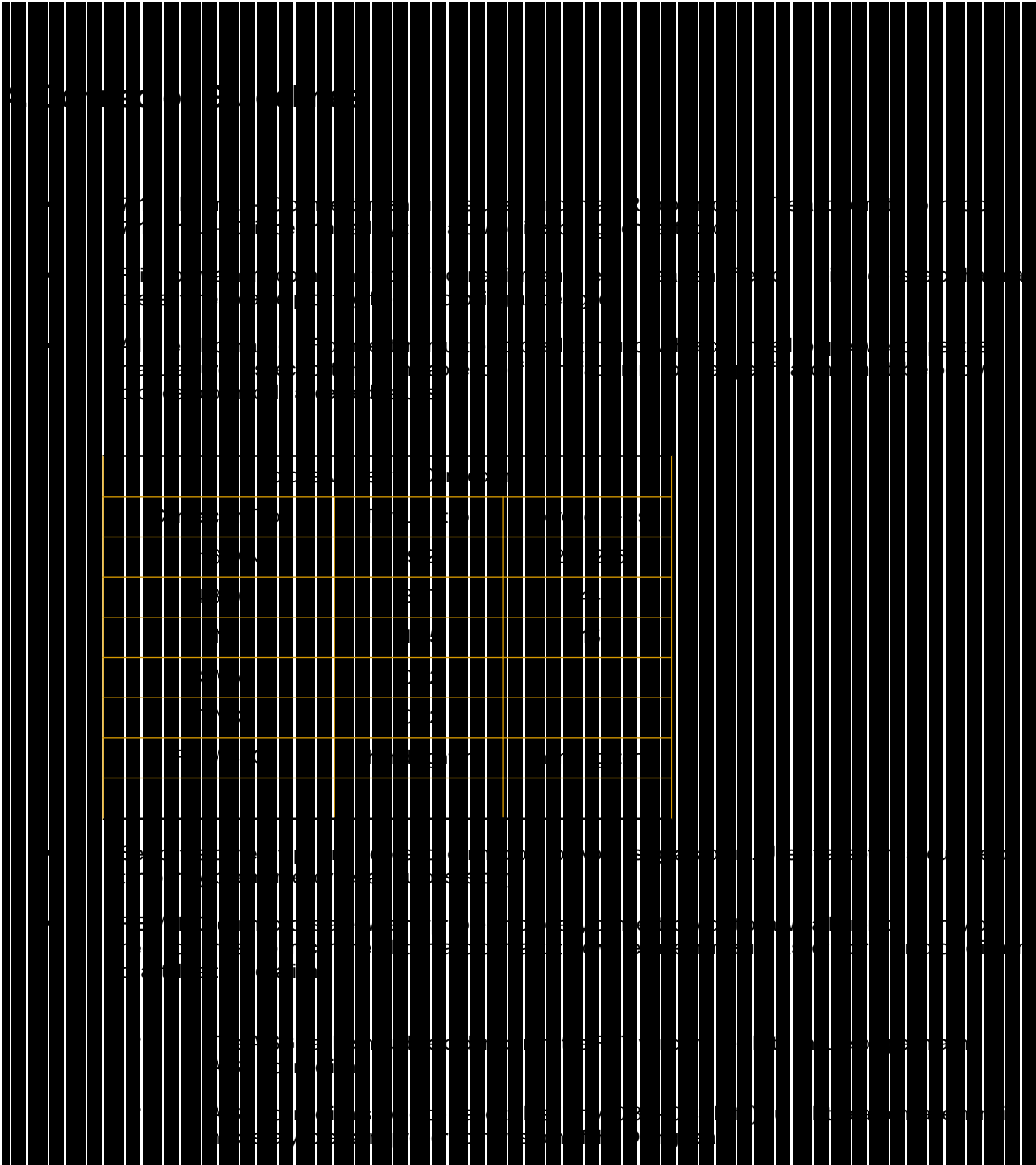

AT&T Proprietary (Internal Use Only)

Not for use or disclosure outside the AT&T companies, except under written agreement.

©2018 AT&T Intellectual Property. All rights reserved.

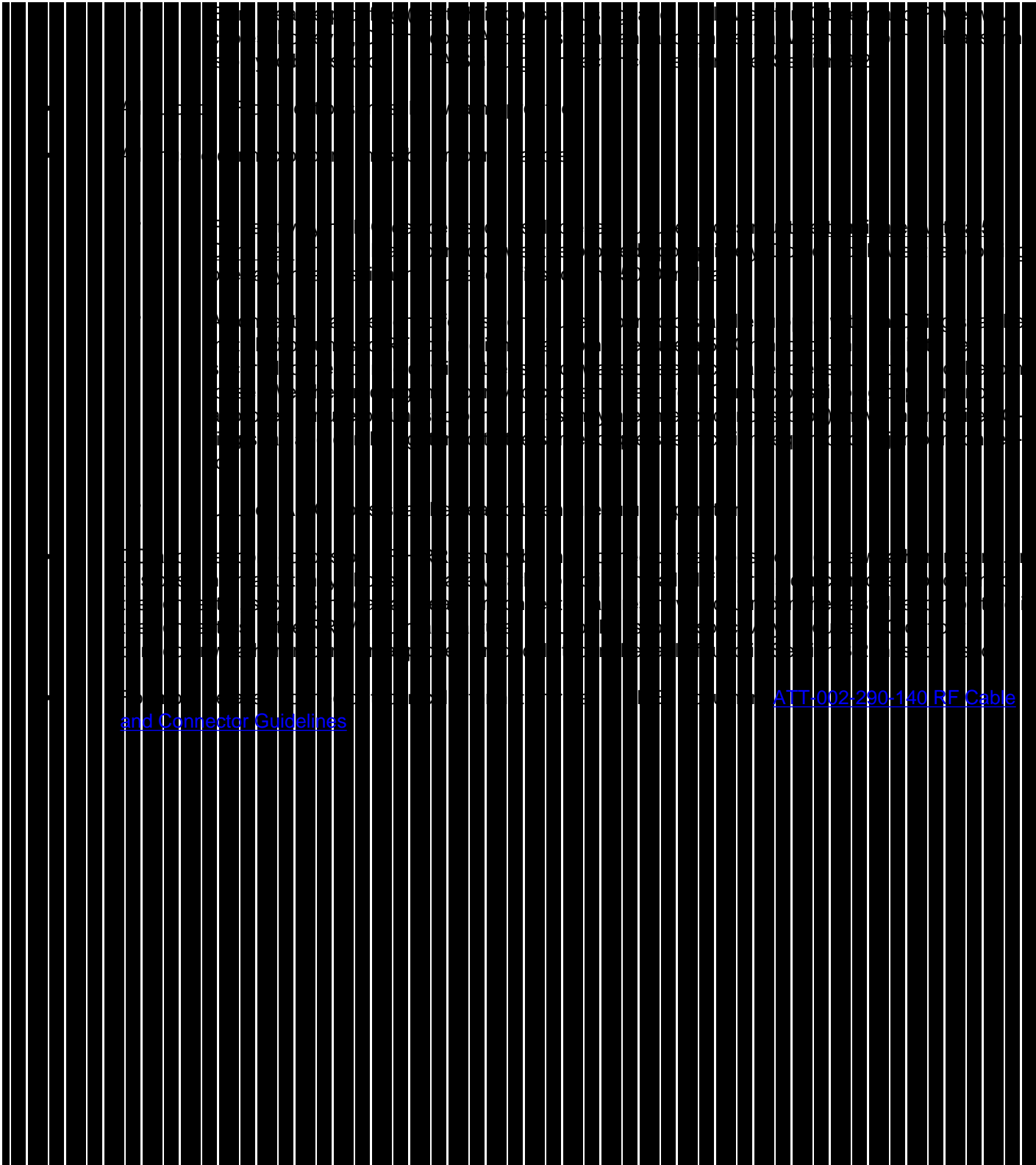

[and Connector Guidelines](#)

[ATT-002-290-140 RF Cable](#)

---

AT&T Proprietary (Internal Use Only)

Not for use or disclosure outside the AT&T companies, except under written agreement.

©2018 AT&T Intellectual Property. All rights reserved.



AT&T Proprietary (Internal Use Only)

Not for use or disclosure outside the AT&T companies, except under written agreement.

©2018 AT&T Intellectual Property. All rights reserved.





AT&T Proprietary (Internal Use Only)

Not for use or disclosure outside the AT&T companies, except under written agreement.

©2018 AT&T Intellectual Property. All rights reserved.



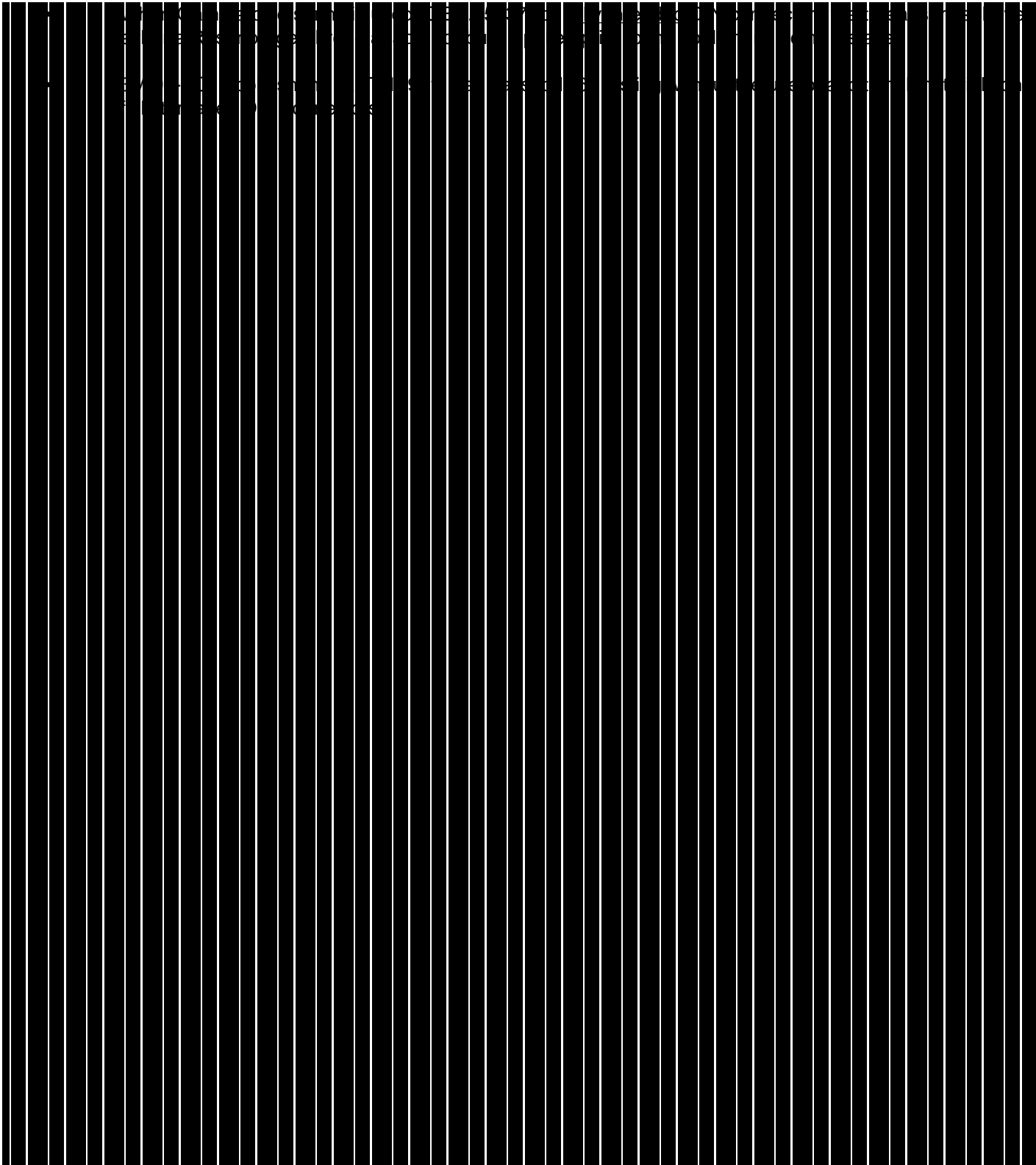

---

AT&T Proprietary (Internal Use Only)

Not for use or disclosure outside the AT&T companies, except under written agreement.

©2018 AT&T Intellectual Property. All rights reserved.



---

AT&T Proprietary (Internal Use Only)

Not for use or disclosure outside the AT&T companies, except under written agreement.

©2018 AT&T Intellectual Property. All rights reserved.





AT&T Proprietary (Internal Use Only)

Not for use or disclosure outside the AT&T companies, except under written agreement.

©2018 AT&T Intellectual Property. All rights reserved.

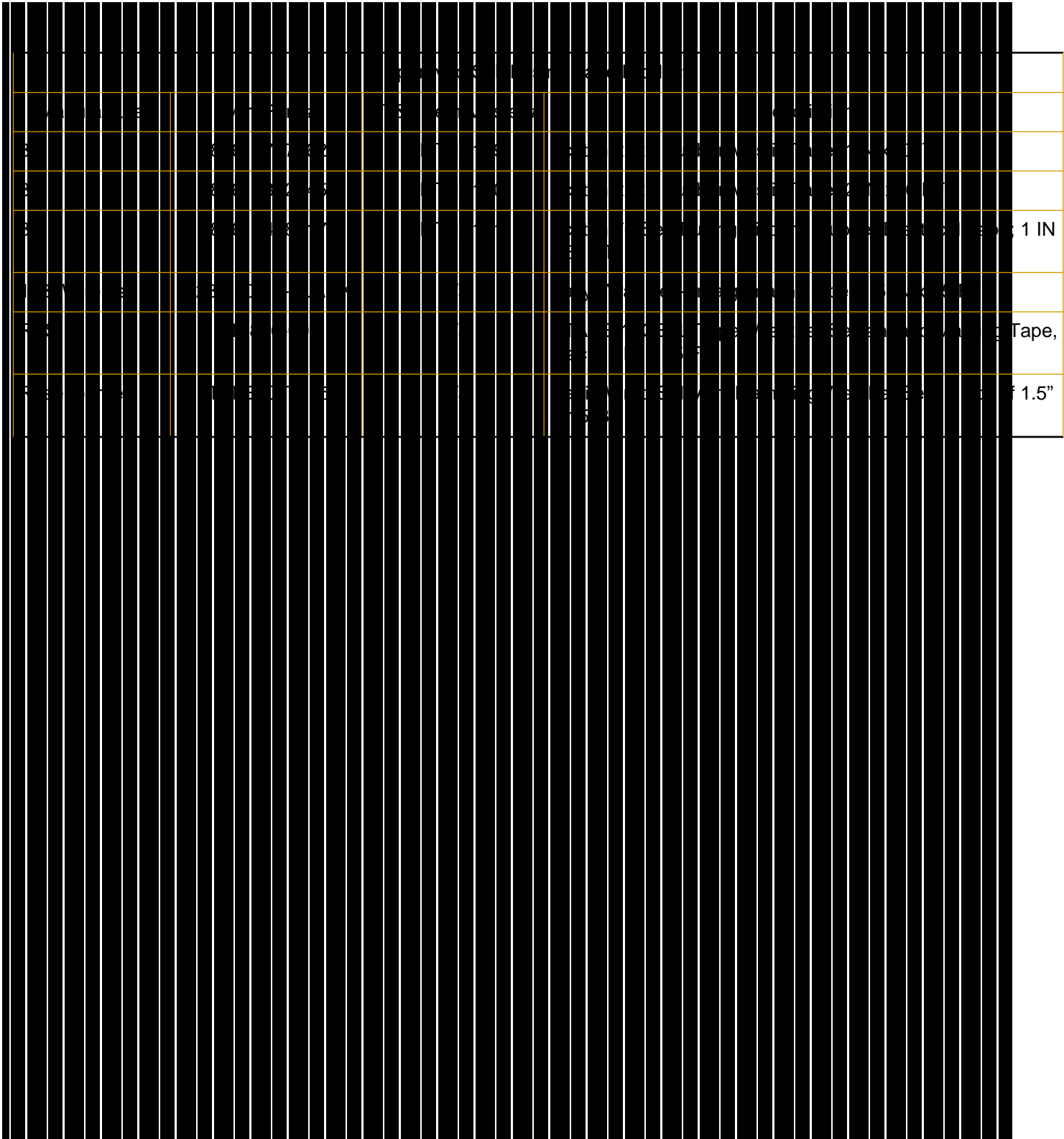

AT&T Proprietary (Internal Use Only)

Not for use or disclosure outside the AT&T companies, except under written agreement.

©2018 AT&T Intellectual Property. All rights reserved.

[RF Hardware Equipment Engineering](#)

[Jumpers Table](#)

[Commscope Approved](#)

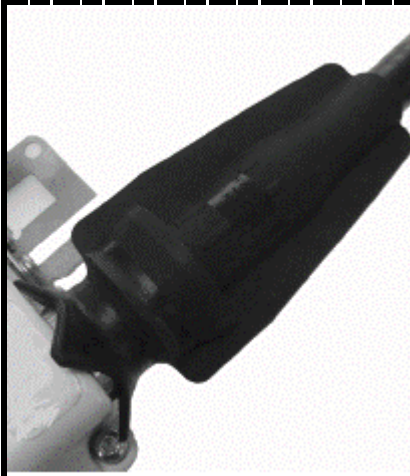

---

AT&T Proprietary (Internal Use Only)

Not for use or disclosure outside the AT&T companies, except under written agreement.

©2018 AT&T Intellectual Property. All rights reserved.

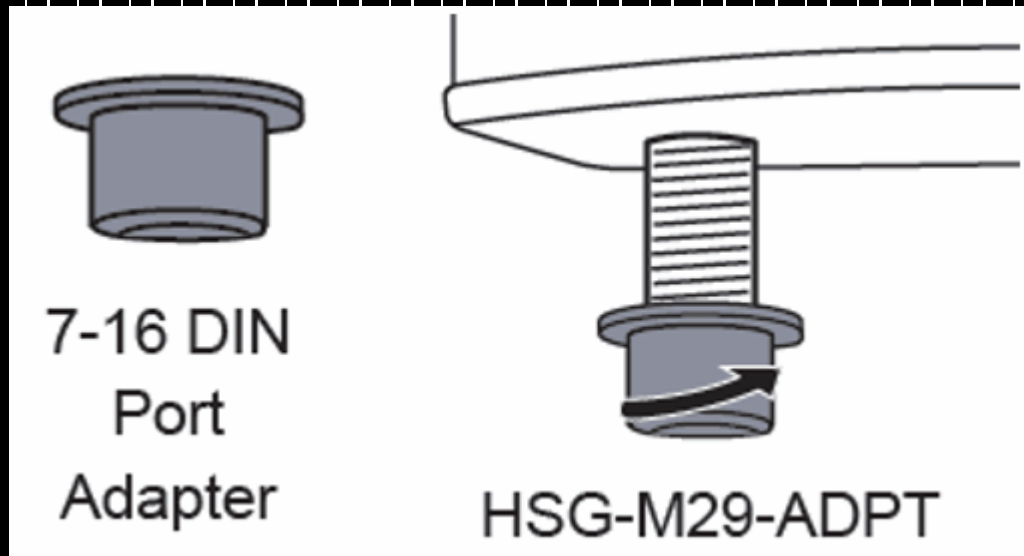
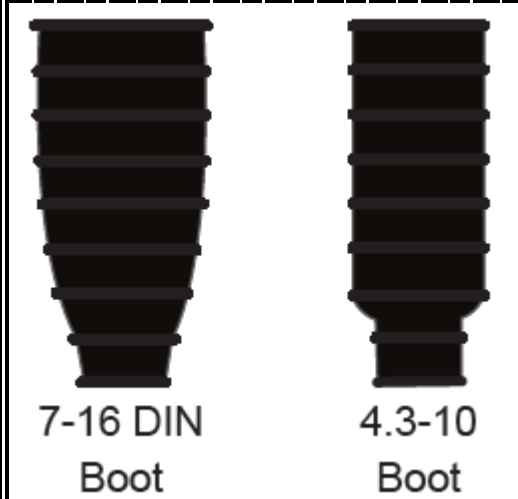
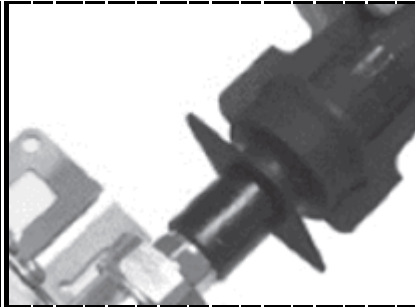

AT&T Proprietary (Internal Use Only)

Not for use or disclosure outside the AT&T companies, except under written agreement.

©2018 AT&T Intellectual Property. All rights reserved.

[Rosenberger Approved Jumpers](#)

[Table](#)

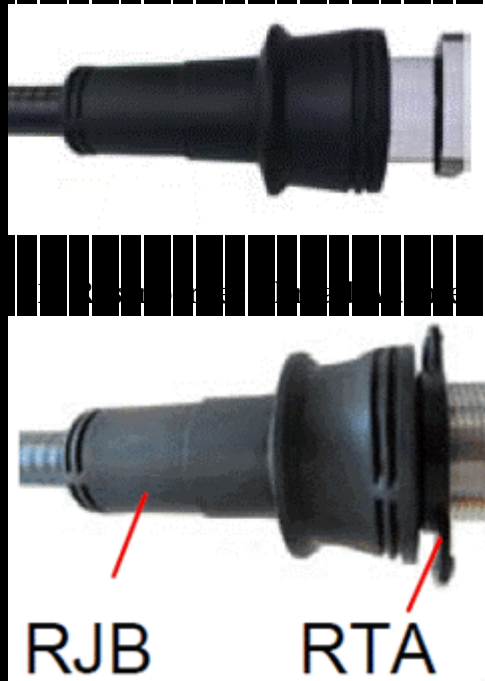

AT&T Proprietary (Internal Use Only)

Not for use or disclosure outside the AT&T companies, except under written agreement.

©2018 AT&T Intellectual Property. All rights reserved.



[RFS Approved Jumpers Table](#)

**Figure 12. Radio Frequency Systems (RFS)**



AT&T Proprietary (Internal Use Only)

Not for use or disclosure outside the AT&T companies, except under written agreement.

©2018 AT&T Intellectual Property. All rights reserved.



---

AT&T Proprietary (Internal Use Only)

Not for use or disclosure outside the AT&T companies, except under written agreement.

©2018 AT&T Intellectual Property. All rights reserved.



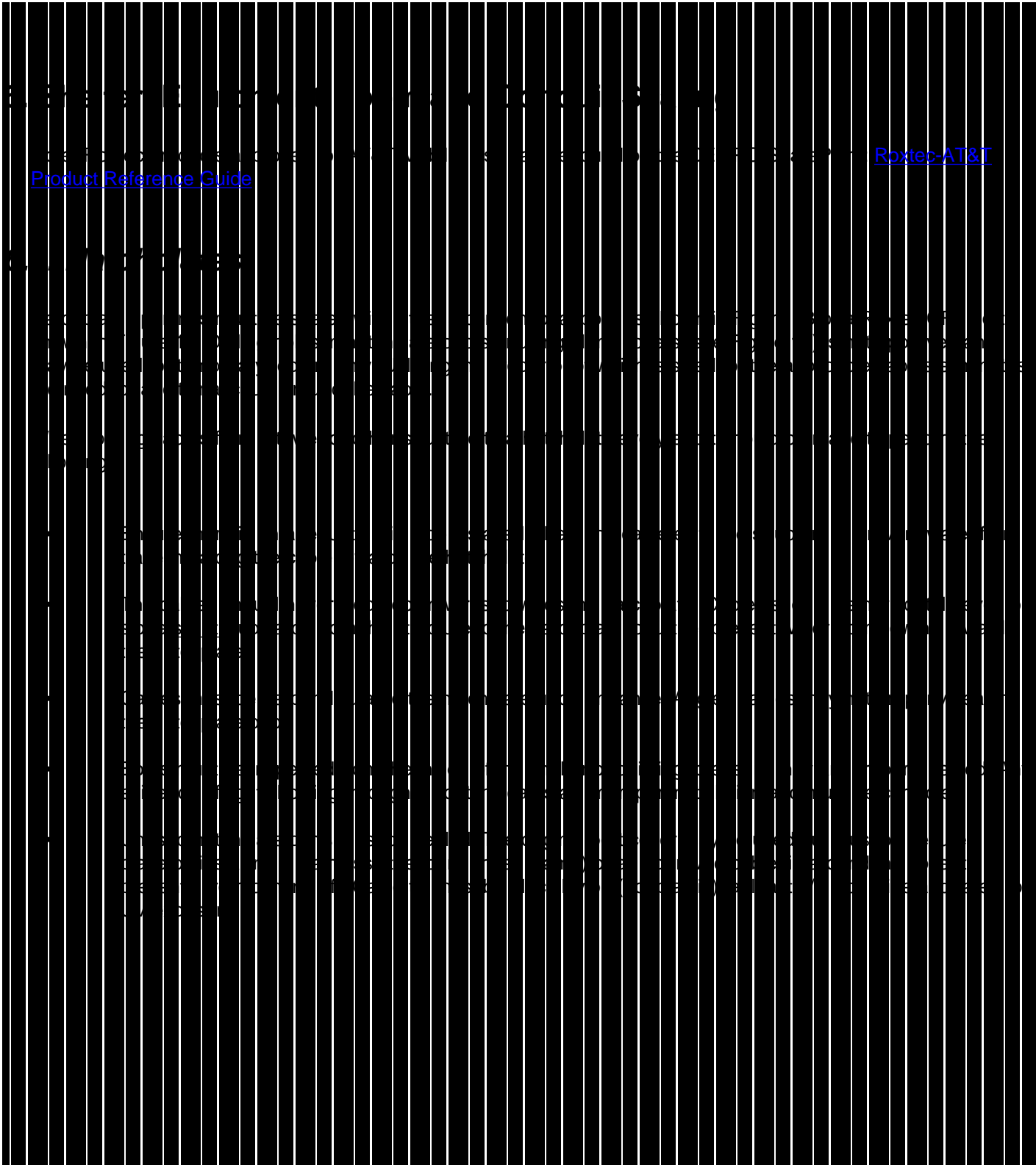

[Product Reference Guide](#)

[Roxtec-AT&T](#)

---

AT&T Proprietary (Internal Use Only)

Not for use or disclosure outside the AT&T companies, except under written agreement.

©2018 AT&T Intellectual Property. All rights reserved.

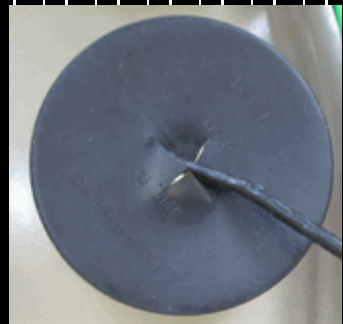

---

AT&T Proprietary (Internal Use Only)

Not for use or disclosure outside the AT&T companies, except under written agreement.

©2018 AT&T Intellectual Property. All rights reserved.



[ATT-002-290-548](#)

---

AT&T Proprietary (Internal Use Only)

Not for use or disclosure outside the AT&T companies, except under written agreement.

©2018 AT&T Intellectual Property. All rights reserved.

[Conduit, Duct and Innerduct Plugging and Sealing](#)

[ATT-TELCO-620-000-291](#)



---

AT&T Proprietary (Internal Use Only)

Not for use or disclosure outside the AT&T companies, except under written agreement.

©2018 AT&T Intellectual Property. All rights reserved.



---

AT&T Proprietary (Internal Use Only)

Not for use or disclosure outside the AT&T companies, except under written agreement.

©2018 AT&T Intellectual Property. All rights reserved.





AT&T Proprietary (Internal Use Only)

Not for use or disclosure outside the AT&T companies, except under written agreement.

©2018 AT&T Intellectual Property. All rights reserved.



---

AT&T Proprietary (Internal Use Only)

Not for use or disclosure outside the AT&T companies, except under written agreement.

©2018 AT&T Intellectual Property. All rights reserved.

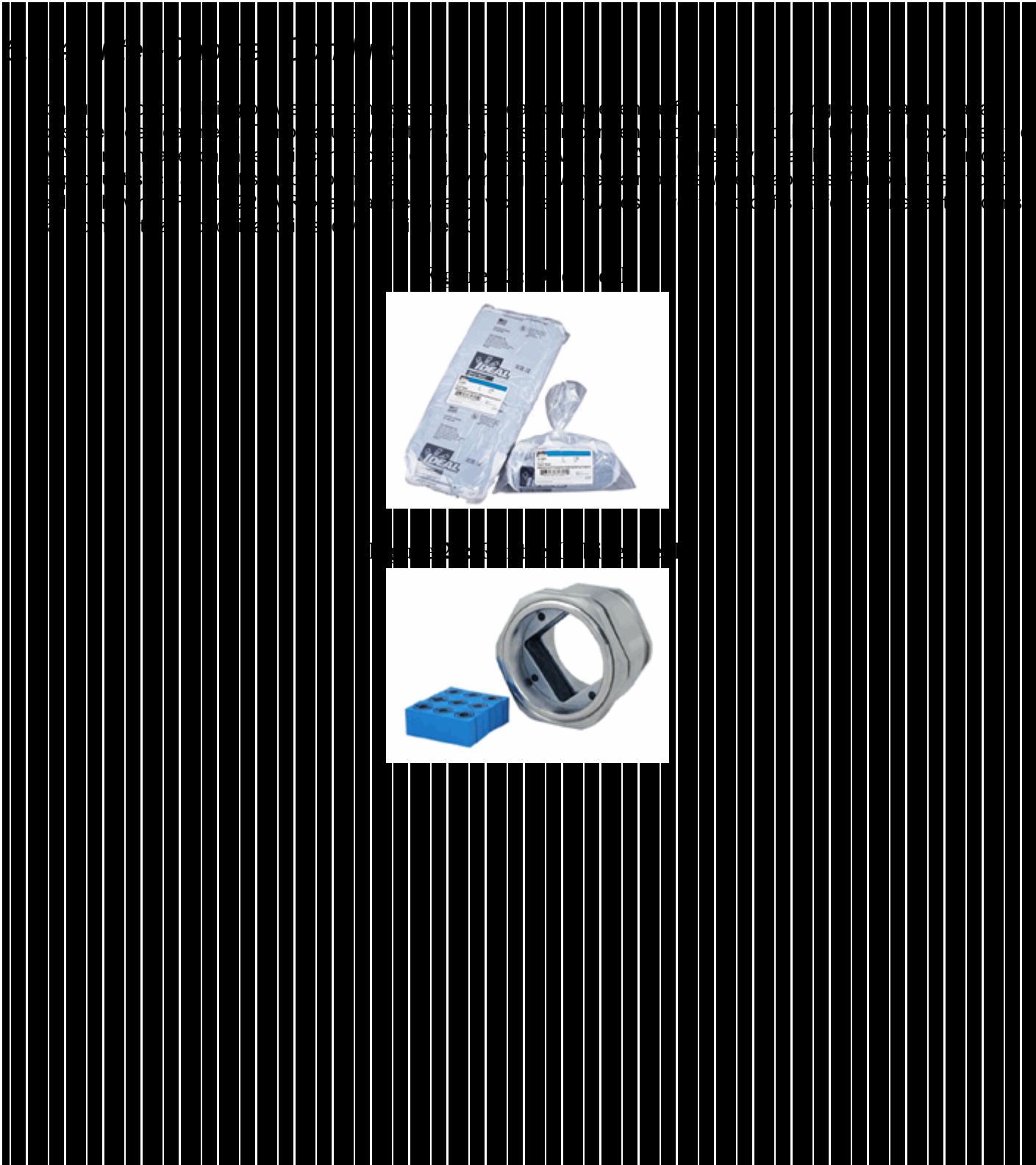

---

AT&T Proprietary (Internal Use Only)

Not for use or disclosure outside the AT&T companies, except under written agreement.

©2018 AT&T Intellectual Property. All rights reserved.

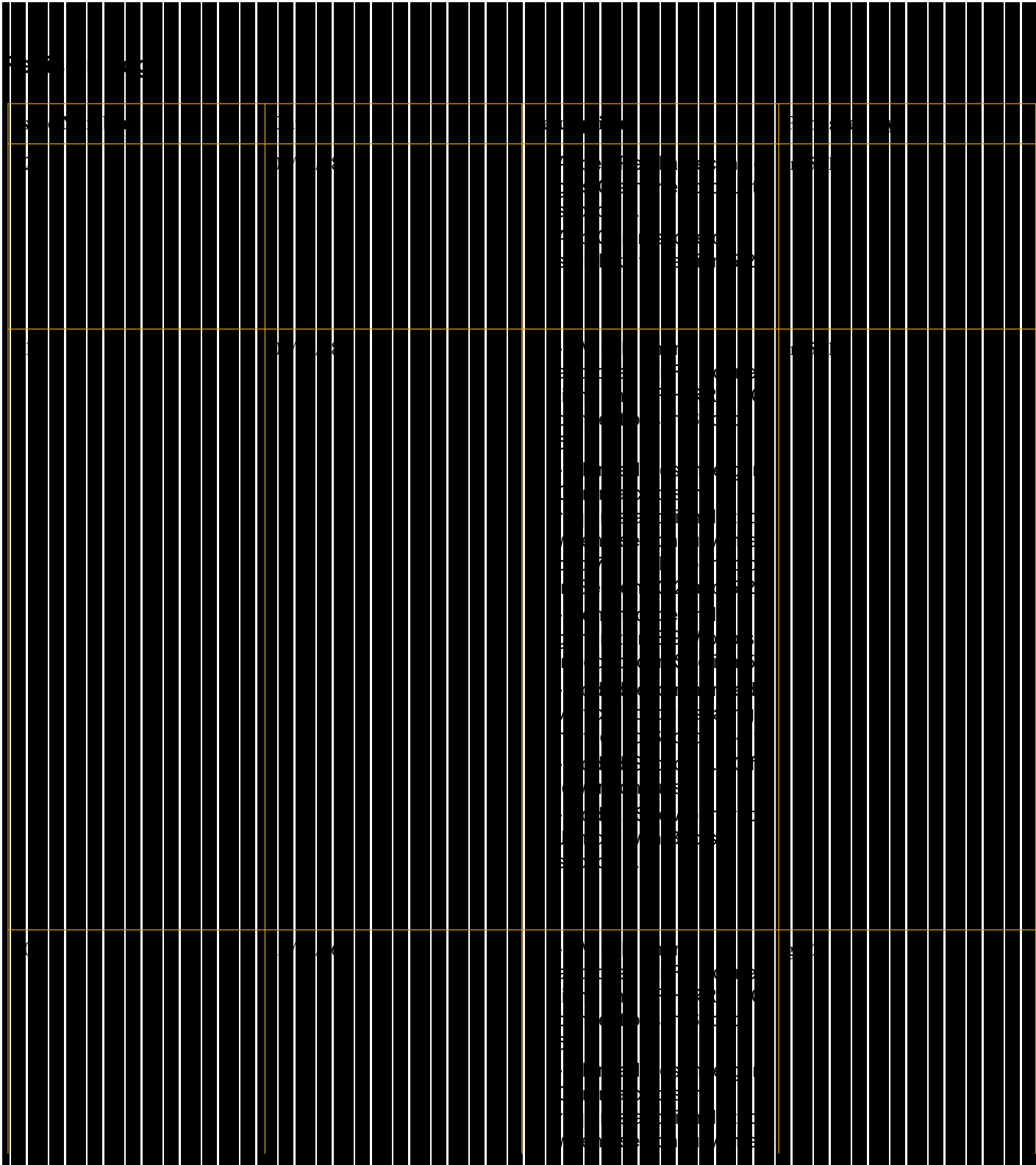

AT&T Proprietary (Internal Use Only)

Not for use or disclosure outside the AT&T companies, except under written agreement.

©2018 AT&T Intellectual Property. All rights reserved.

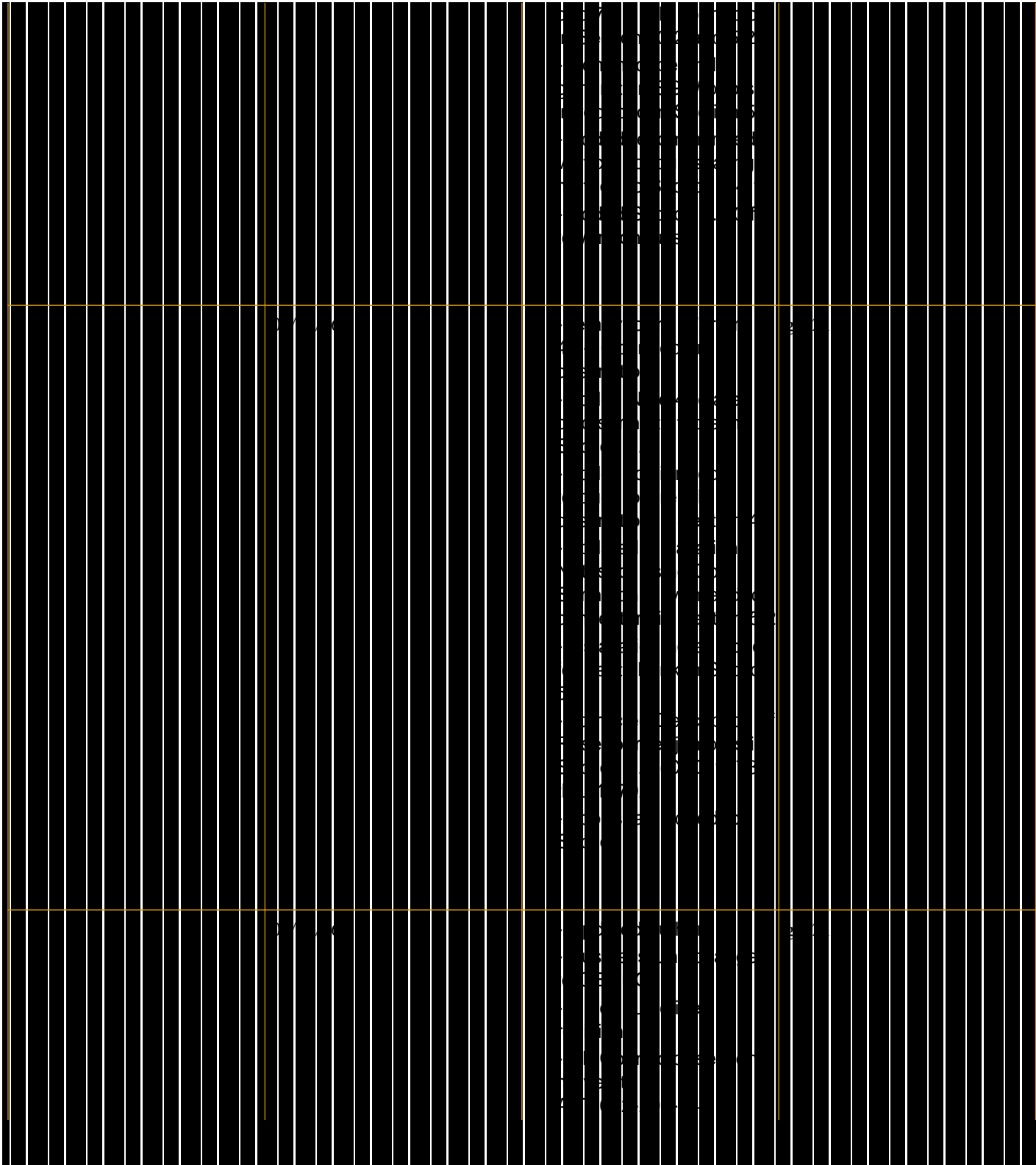

---

AT&T Proprietary (Internal Use Only)

Not for use or disclosure outside the AT&T companies, except under written agreement.

©2018 AT&T Intellectual Property. All rights reserved.

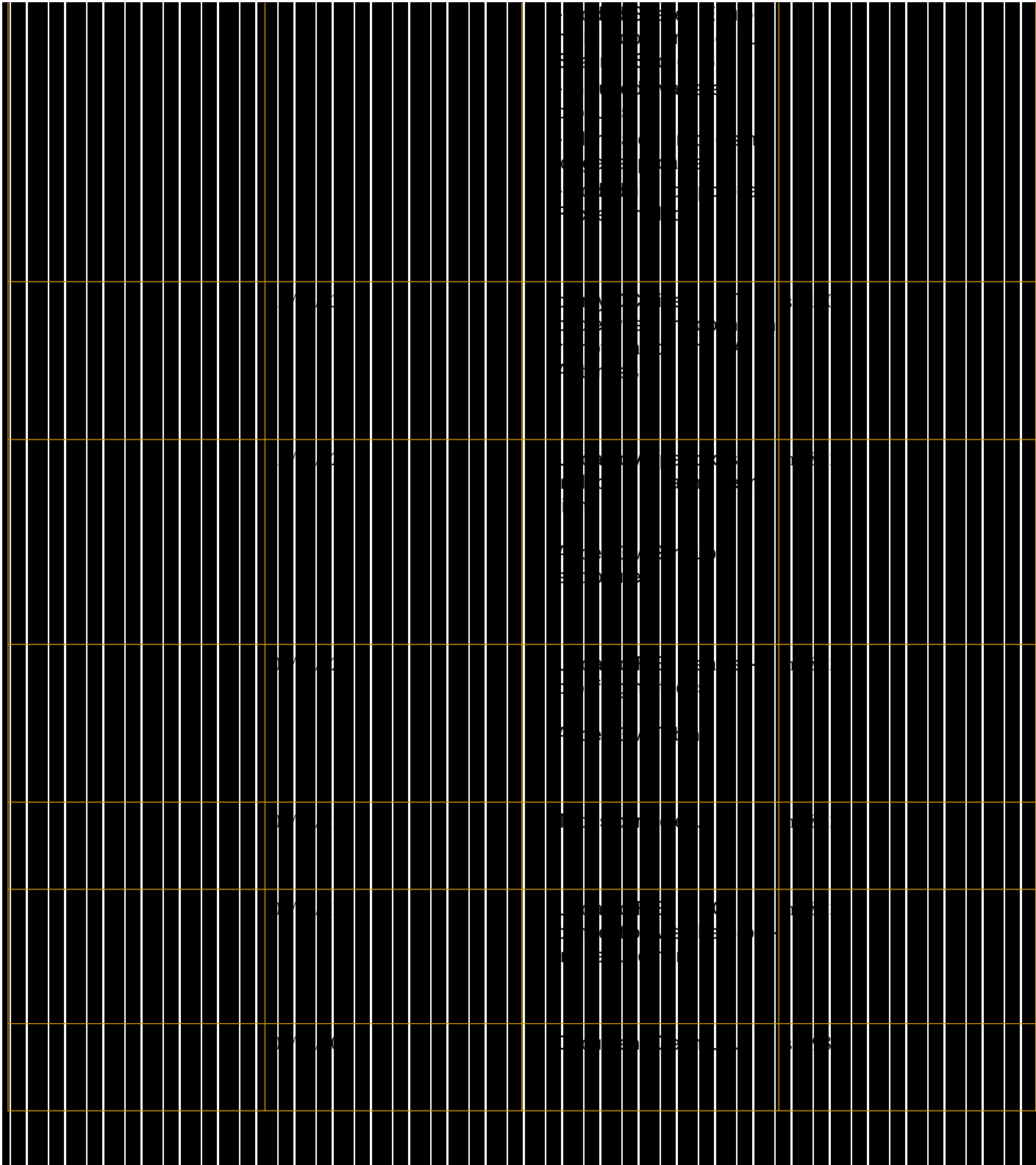

AT&T Proprietary (Internal Use Only)

Not for use or disclosure outside the AT&T companies, except under written agreement.

©2018 AT&T Intellectual Property. All rights reserved.